

Twister II NA Specialist's Guide

TWISTER II NA



PER:
FOR:

AZBE (E)

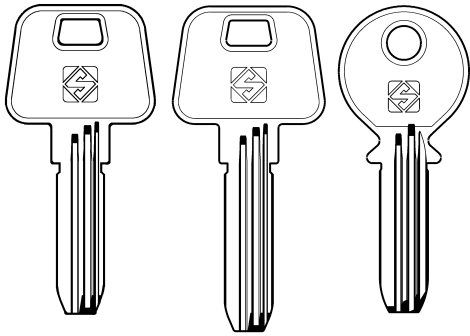

U-TT
AZ6

U-TT
AZ7

U-TT
AZ8

CAVERS (F)

OPTIONAL



D741446ZB

Tracer point TE11
Tastatore TE11
Taster TE11
Palpeur TE11
Palpador TE11
Palpador TE11

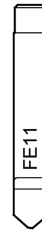
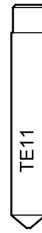

D741447ZB

Cutter FE11
Fresa FE11
Fräser FE11
Fraise FE11
Fresa FE11
Fresa FE11

PER:
FOR:

CISA (I)

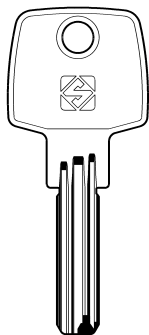

U-TT
CS48

OPTIONAL



D741430ZB

Tracer point TE03
Tastatore TE03
Taster TE03
Palpeur TE03
Palpador TE03
Palpador TE03

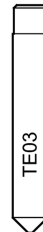

D741431ZB

Cutter FE03
Fresa FE03
Fräser FE03
Fraise FE03
Fresa FE03
Fresa FE03



TWISTER II NA



PER:
FOR:

CISA (I)

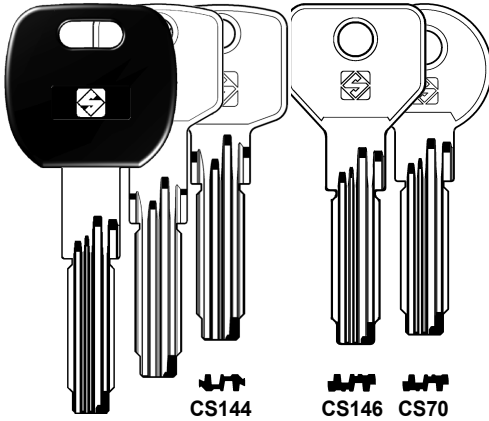

CS144

CS146 CS70

CS62P CS62

CS70P CS115

CS116P CS139

CS139P CS140

CS141

CS145

NEW ASTRAL - ASIX

OPTIONAL

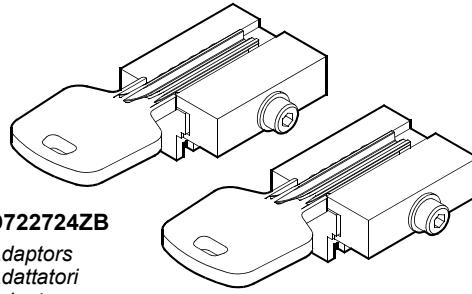

D722724ZB

Adaptors
Adattatori
Adapters
Adaptateurs
Adaptadores
Adaptadores

OPTIONAL



D741430ZB

Tracer point TE03
Tastatore TE03
Taster TE03
Palpeur TE03
Palpador TE03
Palpador TE03



D741431ZB

Cutter FE03
Fresa FE03
Fräser FE03
Fraise FE03
Fresa FE03
Fresa FE03

PER:
FOR:

ELZETT (H)

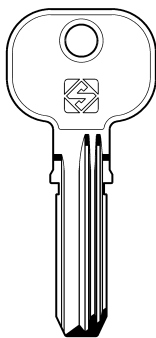

EL9

OPTIONAL



D741430ZB

Tracer point TE03
Tastatore TE03
Taster TE03
Palpeur TE03
Palpador TE03
Palpador TE03

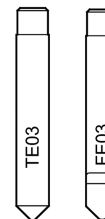

D741431ZB

Cutter FE03
Fresa FE03
Fräser FE03
Fraise FE03
Fresa FE03
Fresa FE03



TWISTER II NA



PER:
FOR: **FICHET (F)**

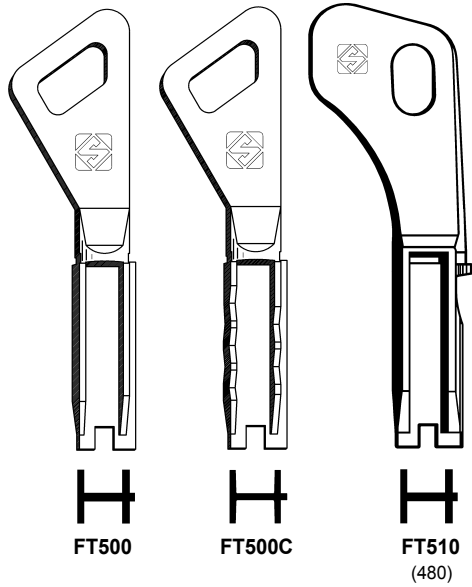

STANDARD



D741432ZB

Tracer point TE04
Tastatore TE04
Taster TE04
Palpeur TE04
Palpador TE04

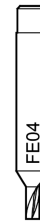
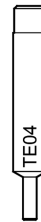

D741433ZB

Cutter FE04
Fresa FE04
Fräser FE04
Fraise FE04
Fresa FE04

PER:
FOR: **FTH (F)**

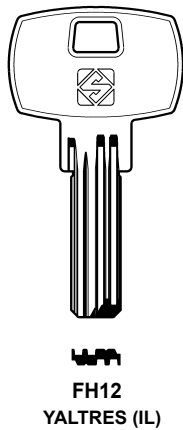

OPTIONAL



D741430ZB

Tracer point TE03
Tastatore TE03
Taster TE03
Palpeur TE03
Palpador TE03

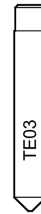

D741431ZB

Cutter FE03
Fresa FE03
Fräser FE03
Fraise FE03
Fresa FE03

PER:
FOR: **ISEO (I)**

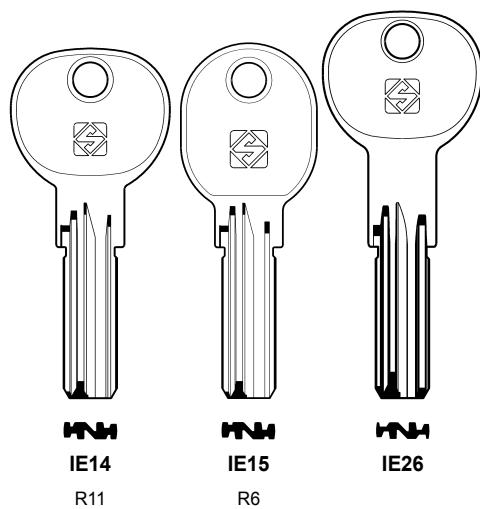

STANDARD



D741128ZB

Tracer point TE01
Tastatore TE01
Taster TE01
Palpeur TE01
Palpador TE01



D741127ZB

Cutter FE01
Fresa FE01
Fräser FE01
Fraise FE01
Fresa FE01



TWISTER II NA



PER:
FOR:

JIS (E)

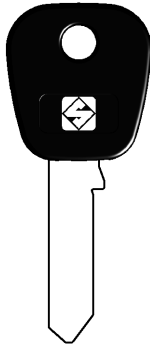

JS5P

OPTIONAL

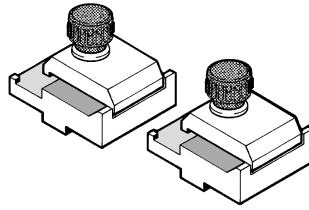

D701664ZB
Adaptors
Adattatori
Adapters
Adaptateurs
Adaptadores
Adaptadores

STANDARD



D741432ZB
Tracer point TE04
Tastatore TE04
Taster TE04
Palpeur TE04
Palpador TE04
Palpador TE04

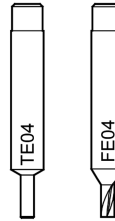

D741433ZB
Cutter FE04
Fresa FE04
Fräser FE04
Fraise FE04
Fresa FE04
Fresa FE04

PER:
FOR:

KABA (CH)

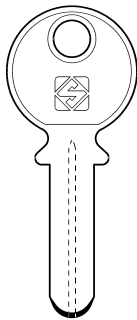

KA1

8

LÄSBOLAGET (S)

OPTIONAL



D741430ZB
Tracer point TE03
Tastatore TE03
Taster TE03
Palpeur TE03
Palpador TE03
Palpador TE03



D741431ZB
Cutter FE03
Fresa FE03
Fräser FE03
Fraise FE03
Fresa FE03
Fresa FE03

PER:
FOR:

KABA (CH)

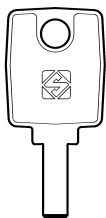

KA8

OPTIONAL

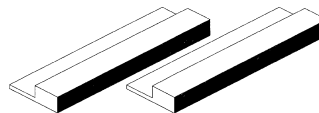

D710008ZB

Adaptors for KABA-Micro
Adattatori per chiavi KABA-Micro
Adapters für KABA-Micro Schlüssel
Adaptateurs pour clés KABA-Micro
Adaptadores para llaves KABA-Micro
Adaptadores para chaves KABA-Micro

OPTIONAL



D741487B
Tracer point TE13
Tastatore TE13
Taster TE13
Palpeur TE13
Palpador TE13
Palpador TE13

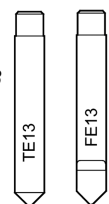

D741488B
Cutter FE13
Fresa FE13
Fräser FE13
Fraise FE13
Fresa FE13
Fresa FE13



TWISTER II NA



PER:
FOR:

MCM (E)

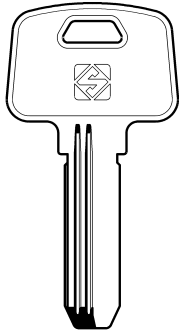

MC10R

OPTIONAL



D741476ZB

*Adaptors
Adattatori
Adapters
Adaptateurs
Adaptadores
Adaptadores*

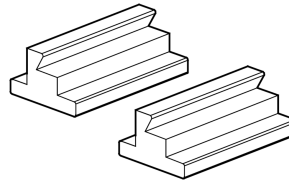

OPTIONAL



D741436ZB

*Tracer point TE06
Tastatore TE06
Taster TE06
Palpeur TE06
Palpador TE06
Palpador TE06*



D741437ZB

*Cutter FE06
Fresa FE06
Fräser FE06
Fraise FE06
Fresa FE06
Fresa FE06*

PER:
FOR:

MCM (E)

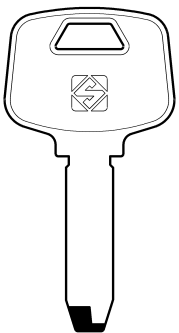

MC9

OPTIONAL



D741442ZB

*Tracer point TE09
Tastatore TE09
Taster TE09
Palpeur TE09
Palpador TE09
Palpador TE09*

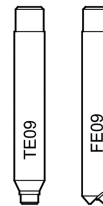

D741443ZB

*Cutter FE09
Fresa FE09
Fräser FE09
Fraise FE09
Fresa FE09
Fresa FE09*

OPTIONAL



D741444ZB

*Tracer point TE10
Tastatore TE10
Taster TE10
Palpeur TE10
Palpador TE10
Palpador TE10*



D741445ZB

*Cutter FE10
Fresa FE10
Fräser FE10
Fraise FE10
Fresa FE10
Fresa FE10*

STANDARD



D741128ZB

*Tracer point TE01
Tastatore TE01
Taster TE01
Palpeur TE01
Palpador TE01
Palpador TE01*



D741127ZB

*Cutter FE01
Fresa FE01
Fräser FE01
Fraise FE01
Fresa FE01
Fresa FE01*



TWISTER II NA



PER:
FOR: **MUL.T.LOCK (IL)**

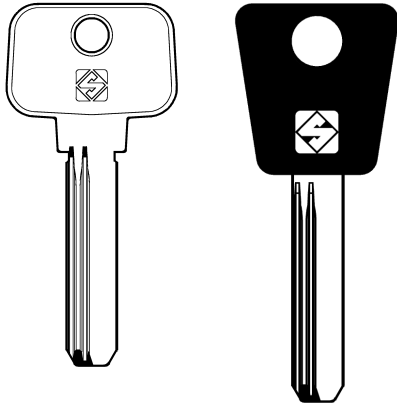

MTK13R
MTK15R
 7X7
MTK13RAP
MTK15RAP
 7X7 (66)

OPTIONAL



D741446ZB
 Tracer point TE11
 Tastatore TE11
 Taster TE11
 Palpeur TE11
 Palpador TE11
 Palpador TE11



D741447ZB
 Cutter FE11
 Fresa FE11
 Fräser FE11
 Fraise FE11
 Fresa FE11
 Fresa FE11

PER:
FOR: **MUL.T.LOCK (IL)**

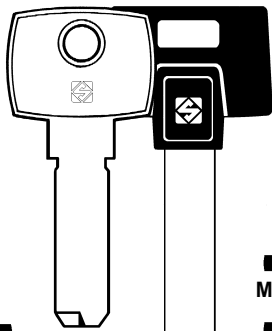

MTK1
MTK2P
MTK3P

STANDARD



D741128ZB
 Tracer point TE01
 Tastatore TE01
 Taster TE01
 Palpeur TE01
 Palpador TE01
 Palpador TE01



D741127ZB
 Cutter FE01
 Fresa FE01
 Fräser FE01
 Fraise FE01
 Fresa FE01
 Fresa FE01

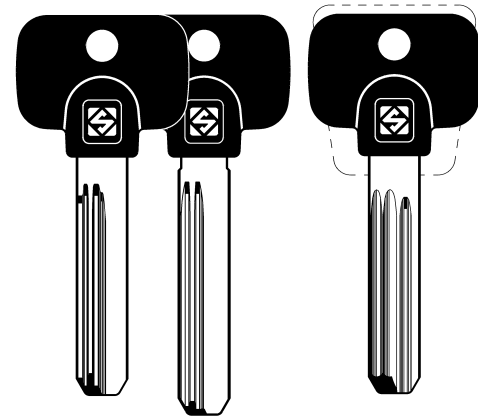

MTK10RP
MTK4RPX
MTK12RP
 Junior
MTK4P
MTK4RP
MTK7RP
MTK8RP
MTK9RP

OPTIONAL



D741440ZB
 Tracer point TE08
 Tastatore TE08
 Taster TE08
 Palpeur TE08
 Palpador TE08
 Palpador TE08

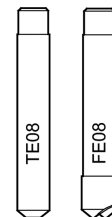

D741441ZB
 Cutter FE08
 Fresa FE08
 Fräser FE08
 Fraise FE08
 Fresa FE08
 Fresa FE08



TWISTER II NA



PER:
FOR:

MOTTURA (I)

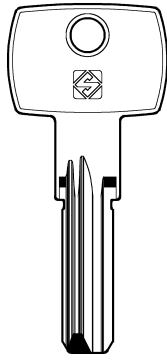

GVY1R

DEFENDER

OPTIONAL



D741446ZB

Tracer point TE11
Tastatore TE11
Taster TE11
Palpeur TE11
Palpador TE11
Palpador TE11



D741447ZB

Cutter FE11
Fresa FE11
Fräser FE11
Fraise FE11
Fresa FE11
Fresa FE11

PER:
FOR:

SEA (CH)

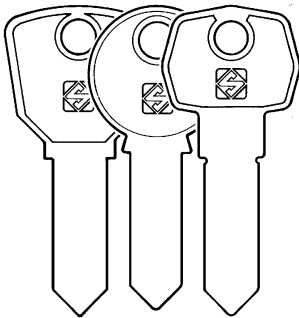

SEB1 SEB2 SEB3

SEA 23 SEA SEA 3
SEA 20 SEA 2

EZCURRA (E)

OPTIONAL



D741448ZB

Tracer point TE12
Tastatore TE12
Taster TE12
Palpeur TE12
Palpador TE12
Palpador TE12



D741449ZB

Cutter FE12
Fresa FE12
Fräser FE12
Fraise FE12
Fresa FE12
Fresa FE12

OPTIONAL



D741430ZB

Tracer point TE03
Tastatore TE03
Taster TE03
Palpeur TE03
Palpador TE03
Palpador TE03



D741431ZB

Cutter FE03
Fresa FE03
Fräser FE03
Fraise FE03
Fresa FE03
Fresa FE03

for SEB1 - SEB3 only
solo per SEB1 - SEB3
Nur für SEB1 - SEB3
Seulement pour SEB1 - SEB3
Solo para SEB1 - SEB3

PER:
FOR:

SECURITAL (I)

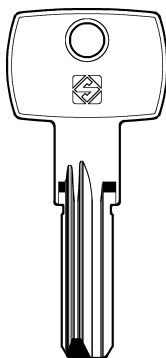

GVY1R

Psei

OPTIONAL



D741436ZB

Tracer point TE06
Tastatore TE06
Taster TE06
Palpeur TE06
Palpador TE06
Palpador TE06



D741437ZB

Cutter FE06
Fresa FE06
Fräser FE06
Fraise FE06
Fresa FE06
Fresa FE06



TWISTER II NA



PER:
FOR:

STS (E)

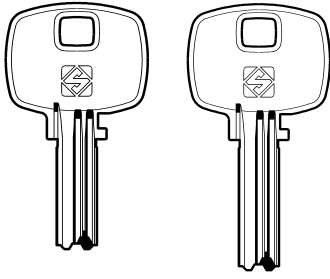

STS5



STS6

OPTIONAL

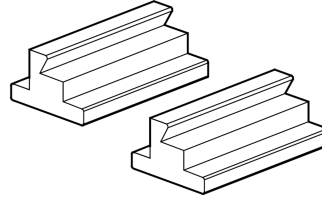

D741476ZB

*Adaptors
Adattatori
Adapters
Adaptateurs
Adaptadores
Adaptadores*



OPTIONAL



D741430ZB

*Tracer point TE03
Tastatore TE03
Taster TE03
Palpeur TE03
Palpador TE03
Palpador TE03*



D741431ZB

*Cutter FE03
Fresa FE03
Fräser FE03
Fraise FE03
Fresa FE03
Fresa FE03*

PER:
FOR:

TESA (E)

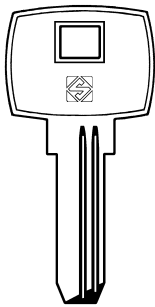

TE4
T10

TE4R

OPTIONAL



D741446ZB

*Tracer point TE11
Tastatore TE11
Taster TE11
Palpeur TE11
Palpador TE11
Palpador TE11*



D741447ZB

*Cutter FE11
Fresa FE11
Fräser FE11
Fraise FE11
Fresa FE11
Fresa FE11*

PER:
FOR:

TESA (E)

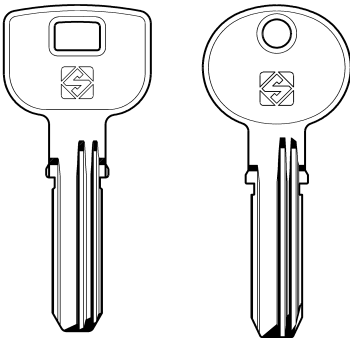

TE5
T80

TE7
T60

OPTIONAL



D741430ZB

*Tracer point TE03
Tastatore TE03
Taster TE03
Palpeur TE03
Palpador TE03
Palpador TE03*



D741431ZB

*Cutter FE03
Fresa FE03
Fräser FE03
Fraise FE03
Fresa FE03
Fresa FE03*



TWISTER II NA



PER:
FOR:

ZADI (I)

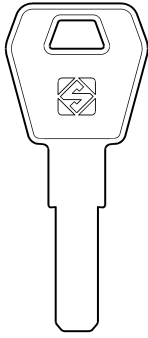

ZD25

OPTIONAL



D741434ZB

Tracer point TE05
Tastatore TE05
Taster TE05
Palpeur TE05
Palpador TE05
Palpador TE05

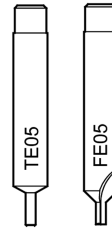

D741435ZB

Cutter FE05
Fresa FE05
Fräser FE05
Fraise FE05
Fresa FE05
Fresa FE05

PER:
FOR:

BMW (D)

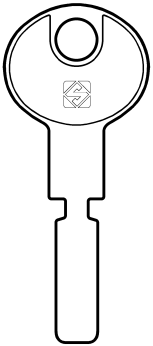

HU59

HU63

HUF (D)
TIBBE (D)

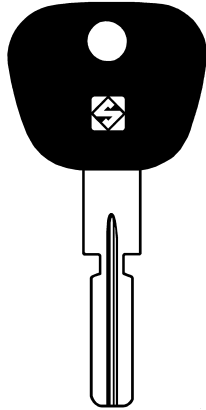

HU58AP

OPTIONAL

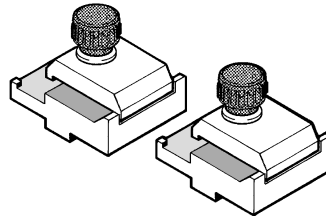

D701664ZB

Adaptors
Adattatori
Adapters
Adaptateurs
Adaptadores
Adaptadores

STANDARD



D741432ZB

Tracer point TE04
Tastatore TE04
Taster TE04
Palpeur TE04
Palpador TE04
Palpador TE04



D741433ZB

Cutter FE04
Fresa FE04
Fräser FE04
Fraise FE04
Fresa FE04
Fresa FE04

PER:
FOR:

BMW (D)

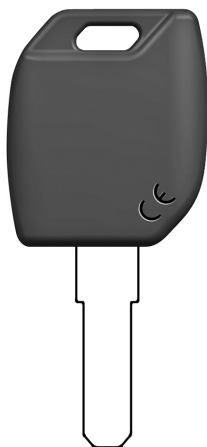

BW9MH

OPTIONAL



D741434ZB

Tracer point TE05
Tastatore TE05
Taster TE05
Palpeur TE05
Palpador TE05
Palpador TE05

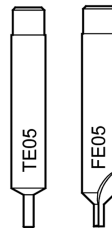

D741435ZB

Cutter FE05
Fresa FE05
Fräser FE05
Fraise FE05
Fresa FE05
Fresa FE05



TWISTER II NA



PER:
FOR: **FORD (EU)**

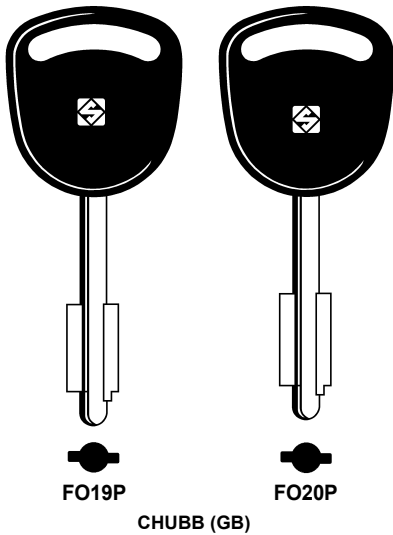

OPTIONAL



D741450ZB

Adaptors for FO19P-FO20P keys
Adattatori per chiavi FO19P-FO20P
Adapters für FO19P-FO20P Schlüssel
Adaptateurs pour clés FO19P-FO20P
Adaptadores para llaves FO19P-FO20P
Adaptadores para chaves FO19P-FO20P

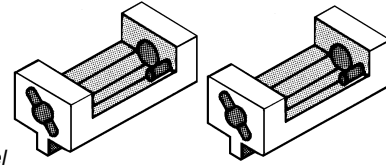

OPTIONAL



D741434ZB

Tracer point TE05
Tastatore TE05
Taster TE05
Palpeur TE05
Palpador TE05
Palpador TE05

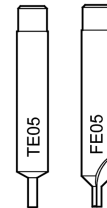

D741435ZB

Cutter FE05
Fresa FE05
Fräser FE05
Fraise FE05
Fresa FE05
Fresa FE05

PER:
FOR: **FORD (EU + USA)**

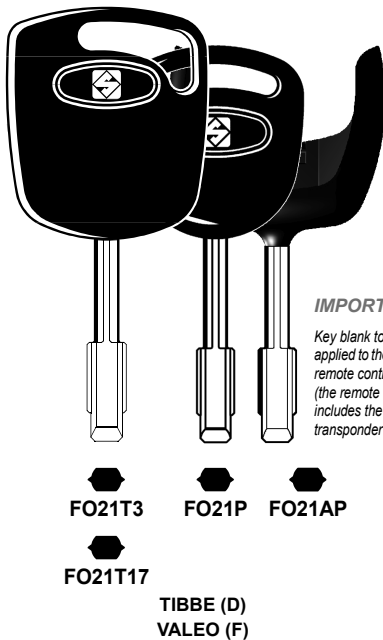

IMPORTANT!

Key blank to be applied to the original remote control (the remote control includes the transponder chip)

OPTIONAL



D741409ZB

Code attachment
Dispositivo a codice
Code-Vorrichtung
Dispositif à code
Dispositivo a código
Dispositivo por código

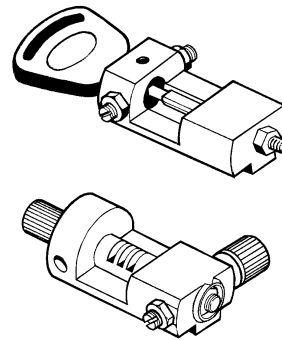

STANDARD

D741432ZB

Tracer point TE04
Tastatore TE04
Taster TE04
Palpeur TE04
Palpador TE04
Palpador TE04



D741433ZB

Cutter FE04
Fresa FE04
Fräser FE04
Fraise FE04
Fresa FE04
Fresa FE04

PER:
FOR: **HONDA (J)**

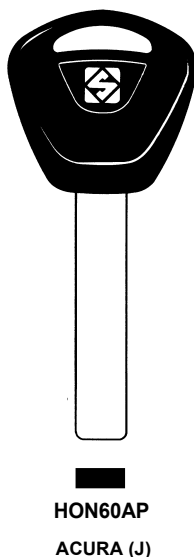

OPTIONAL



D741434ZB

Tracer point TE05
Tastatore TE05
Taster TE05
Palpeur TE05
Palpador TE05
Palpador TE05



D741435ZB

Cutter FE05
Fresa FE05
Fräser FE05
Fraise FE05
Fresa FE05
Fresa FE05



TWISTER II NA



PER:
FOR:

HONDA (J)

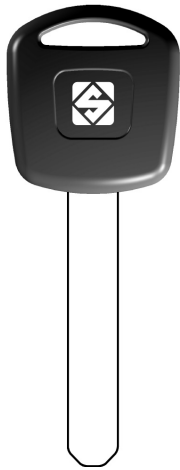

HON66GP

HON66T5
HON66T6
HON66T14
HOV01T5

STANDARD



D741432ZB

Tracer point TE04
Tastatore TE04
Taster TE04
Palpeur TE04
Palpador TE04
Palpador TE04

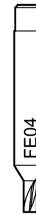
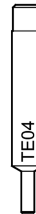

D741433ZB

Cutter FE04
Fresa FE04
Fräser FE04
Fraise FE04
Fresa FE04
Fresa FE04

PER:
FOR:

HUF (D)

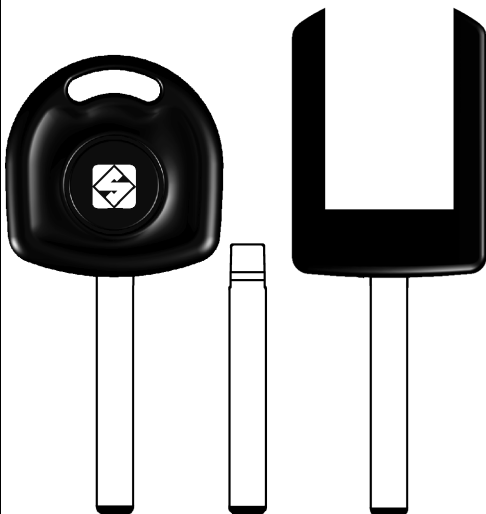

HU100T12

HU100T

HU100BT12

OPEL

HU100AT12

STANDARD



D741432ZB

Tracer point TE04
Tastatore TE04
Taster TE04
Palpeur TE04
Palpador TE04
Palpador TE04

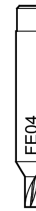
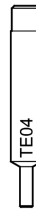

D741433ZB

Cutter FE04
Fresa FE04
Fräser FE04
Fraise FE04
Fresa FE04
Fresa FE04

PER:
FOR:

HUF (D)

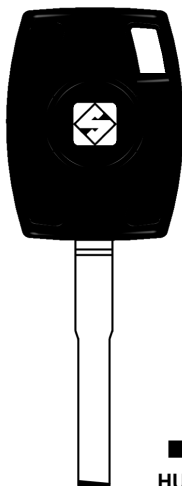

HU101...

STANDARD



D741432ZB

Tracer point TE04
Tastatore TE04
Taster TE04
Palpeur TE04
Palpador TE04
Palpador TE04



D741433ZB

Cutter FE04
Fresa FE04
Fräser FE04
Fraise FE04
Fresa FE04
Fresa FE04



TWISTER II NA



PER:
FOR:

HUF (D)

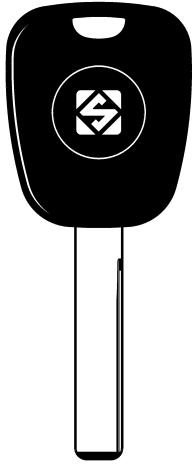

HU92RP

OPTIONAL



D727645ZB

*Adaptors A16 for HU92RP keys
Adattatori A16 per chiavi HU92RP
Adapters A16 für HU92RP Schlüssel
Adaptateurs A16 pour clés HU92RP
Adaptadores A16 para llaves HU92RP
Adaptadores A16 para chaves HU92RP*

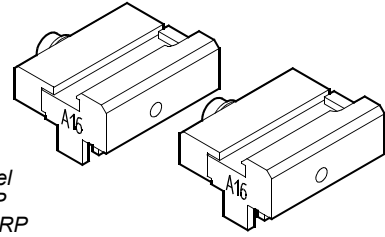

STANDARD



D741432ZB

*Tracer point TE04
Tastatore TE04
Taster TE04
Palpeur TE04
Palpador TE04
Palpador TE04*

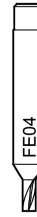

D741433ZB

*Cutter FE04
Fresa FE04
Fräser FE04
Fraise FE04
Fresa FE04
Fresa FE04*

PER:
FOR:

HUF (D)

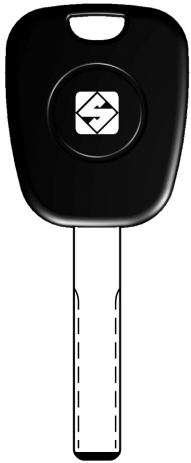

HU83T5



HU83T



HU107T

STANDARD



D741432ZB

*Tracer point TE04
Tastatore TE04
Taster TE04
Palpeur TE04
Palpador TE04
Palpador TE04*

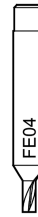
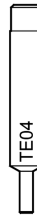

D741433ZB

*Cutter FE04
Fresa FE04
Fräser FE04
Fraise FE04
Fresa FE04
Fresa FE04*



TWISTER II NA



PER:
FOR:

MERCEDES (D)

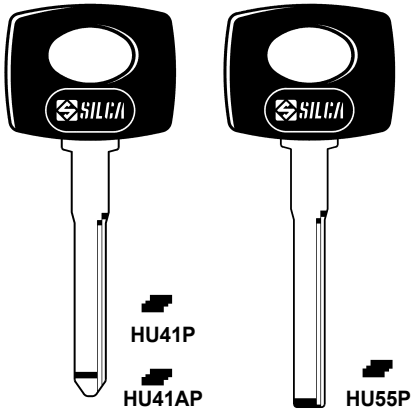

HU41P
HU41AP

HU55P

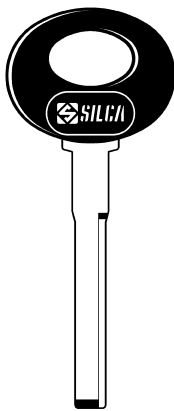

HU61AP



HU64P

HU64T
HUF (D)

HU65AP

OPTIONAL

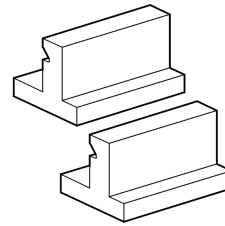

D726291ZB

Adapters for MERCEDES keys
Adattatori per chiavi MERCEDES
Adapters für MERCEDES Schlüssel
Adaptateurs pour clés MERCEDES
Adaptadores para llaves MERCEDES
Adaptadores para chaves MERCEDES

STANDARD



D741432ZB

Tracer point TE04
Tastatore TE04
Taster TE04
Palpeur TE04
Palpador TE04
Palpador TE04



D741433ZB

Cutter FE04
Fresa FE04
Fräser FE04
Fraise FE04
Fresa FE04
Fresa FE04



TWISTER II NA



PER:
FOR: **MERCEDES (D)**

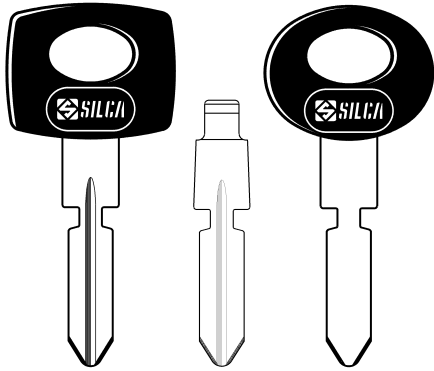

HU39P
HU39T
HU40P
HUF (D)

OPTIONAL

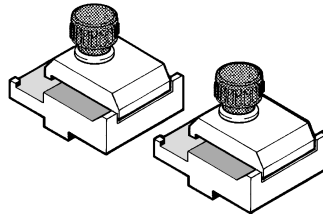

D701664ZB

Adaptors
Adattatori
Adapters
Adaptateurs
Adaptadores
Adaptadores

STANDARD



D741432ZB

Tracer point TE04
Tastatore TE04
Taster TE04
Palpeur TE04
Palpador TE04
Palpador TE04



D741433ZB

Cutter FE04
Fresa FE04
Fräser FE04
Fraise FE04
Fresa FE04
Fresa FE04

PER:
FOR: **OPEL-VAUXHALL (D)**

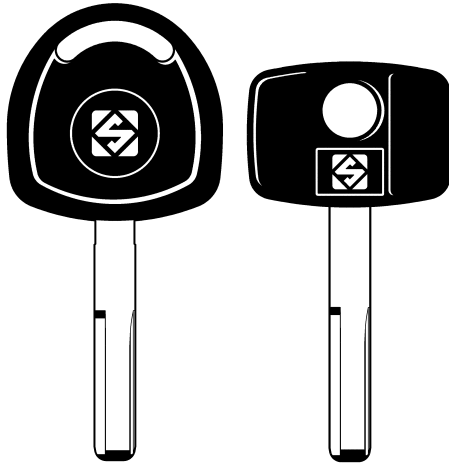

HU43T9
HU43AT9
HU43T
HU43TGM

HU43P

OPTIONAL



D741429ZB

Code device
Dispositivo a codice
Code-Vorrichtung
Dispositif à code
Dispositivo a código
Dispositivo por código

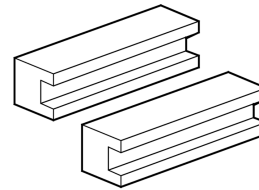

STANDARD



D741432ZB

Tracer point TE04
Tastatore TE04
Taster TE04
Palpeur TE04
Palpador TE04
Palpador TE04



D741433ZB

Cutter FE04
Fresa FE04
Fräser FE04
Fraise FE04
Fresa FE04
Fresa FE04

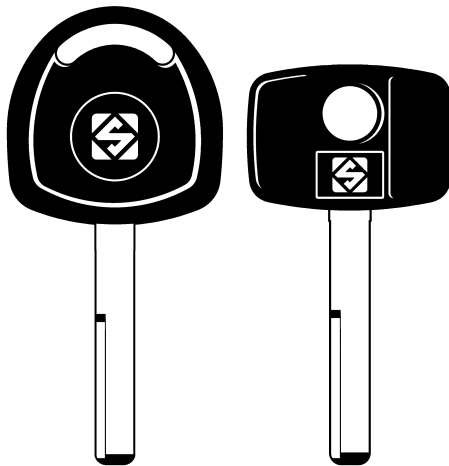

YM27T2

YM27P







TWISTER II NA

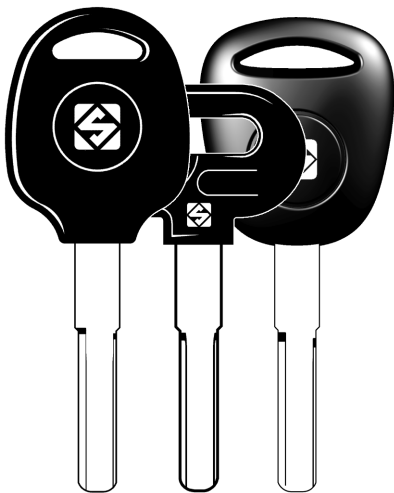

PER:
FOR:

SAAB (S)



 **YM30BP**
 **YM30P**
 **YM30T5**
VALEO-YMOS (D) **YMOS (D)**

OPTIONAL

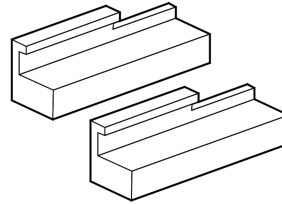

D741427ZB

Adaptors for YM30P-YM30BP keys
Adattatori per chiavi YM30P-YM30BP
Adapters für YM30P-YM30BP Schlüssel
Adaptateurs pour clés YM30P-YM30BP
Adaptadores para llaves YM30P-YM30BP
Adaptadores para chaves YM30P-YM30BP

STANDARD



D741432ZB

Tracer point TE04
Tastatore TE04
Taster TE04
Palpeur TE04
Palpador TE04
Palpador TE04



D741433ZB

Cutter FE04
Fresa FE04
Fräser FE04
Fraise FE04
Fresa FE04
Fresa FE04

PER:
FOR:

TRW SIPEA (I)

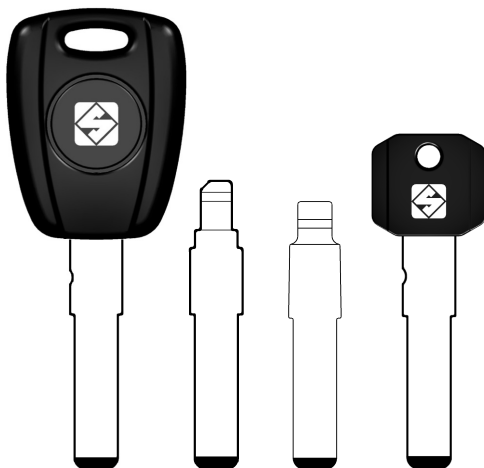

 **SIP22LP**
 **SIP29T**
 **SIP18T**
 **SIP22KP**
 **SIP22T5**

OPTIONAL



D741434ZB

Tracer point TE05
Tastatore TE05
Taster TE05
Palpeur TE05
Palpador TE05
Palpador TE05

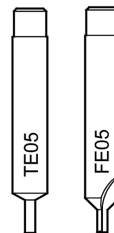

D741435ZB

Cutter FE05
Fresa FE05
Fräser FE05
Fraise FE05
Fresa FE05
Fresa FE05





TWISTER II NA



PER:
FOR: **TOYOTA (J)**





TOY40BT4
TOY40
TOY40P
TOY40AP

TOY48P

TOY48BT4
ARISTO

STANDARD

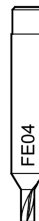
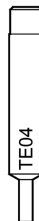



D741432ZB
Tracer point TE04
Tastatore TE04
Taster TE04
Palpeur TE04
Palpador TE04
Palpador TE04



D741433ZB
Cutter FE04
Fresa FE04
Fräser FE04
Fraise FE04
Fresa FE04
Fresa FE04

PER:
FOR: **VALEO (F)**



 
VA2T14 VA6 ...

STANDARD



D741432ZB
Tracer point TE04
Tastatore TE04
Taster TE04
Palpeur TE04
Palpador TE04
Palpador TE04

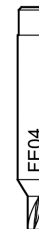

D741433ZB
Cutter FE04
Fresa FE04
Fräser FE04
Fraise FE04
Fresa FE04
Fresa FE04



TWISTER II NA



PER:
FOR:

VOLVO (S)

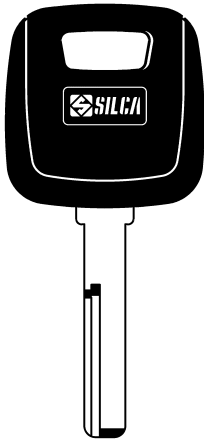

HU56RAT2

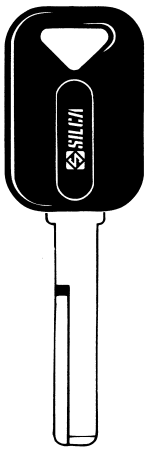

HU57RP

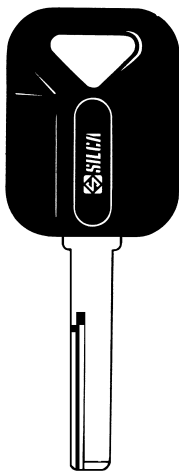



HU56RP

STANDARD

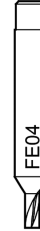
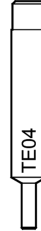

D741432ZB

Tracer point TE04
Tastatore TE04
Taster TE04
Palpeur TE04
Palpador TE04
Palpador TE04



D741433ZB

Cutter FE04
Fresa FE04
Fräser FE04
Fraise FE04
Fresa FE04
Fresa FE04

PER:
FOR:

ZADI (I)

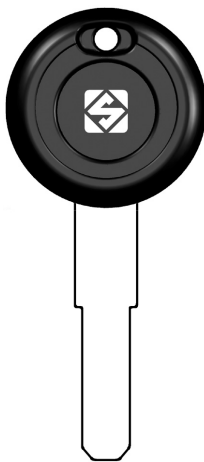



ZD30T5

OPTIONAL

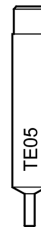

D741434ZB

Tracer point TE05
Tastatore TE05
Taster TE05
Palpeur TE05
Palpador TE05
Palpador TE05



D741435ZB

Cutter FE05
Fresa FE05
Fräser FE05
Fraise FE05
Fresa FE05
Fresa FE05



TWISTER II NA



PER:
FOR:

AUDI (D)
FORD (D)
PORSCHE (D)
SEAT (E)
SKODA (CZ)
VOLKSWAGEN (D)

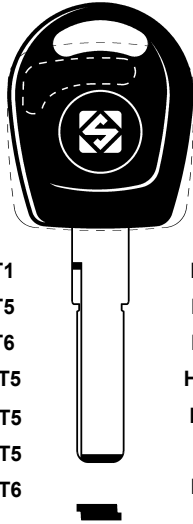

HU66T1	HU66AT6
HU66T5	HU66T10
HU66T6	HU66T15
HU66AT5	HU66BT15
HU66CT5	HU66BT1
HU66DT5	HU66PL
HU66CT6	HU66T5L
	HU75T
	HU103T

HUF (D)
WITTE (D)

OPTIONAL

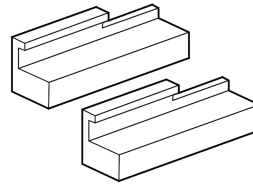

D741427ZB

Adaptors for YM30P-YM30BP keys
Adattatori per chiavi YM30P-YM30BP
Adapters für YM30P-YM30BP Schlüssel
Adaptateurs pour clés YM30P-YM30BP
Adaptadores para llaves YM30P-YM30BP
Adaptadores para chaves YM30P-YM30BP

STANDARD

D741432ZB

Tracer point TE04
Tastatore TE04
Taster TE04
Palpeur TE04
Palpador TE04
Palpador TE04

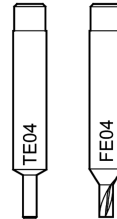

D741433ZB

Cutter FE04
Fresa FE04
Fräser FE04
Fraise FE04
Fresa FE04
Fresa FE04

PER:
FOR:

CENTURY (USA)

CEN5T (10)

CHICAGO (USA)

CH16T (9.2)
CH17T (10)

L&F (GB)

ERA (GB)

AGA (E)

MERONI (I)

MER22T (9.50)
MER25T (9.50)

P.CORTELLEZZI (I)

PC12T (9.60)
PC12TP (9.60)
PC15T (9.60)
PC15TP (9.60)

SILCA (I)

SLC1TP (9.60)
SLC2TP (9.60)

SIDLEEN (USA)

SD3T (9.50)

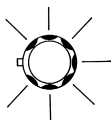
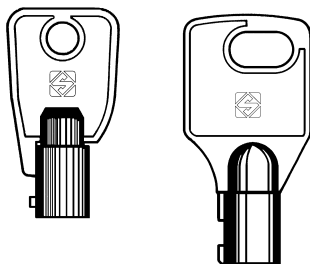

OPTIONAL

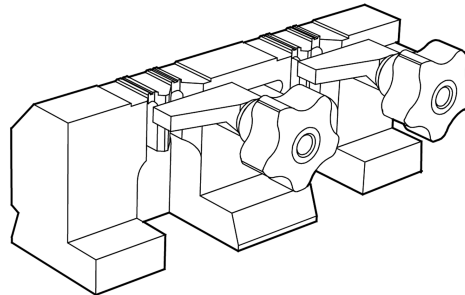

D741428ZB

Device for tubular keys
Dispositivo per chiavi tubolari
Vorrichtung für Steckschlüssel
Dispositif pour clés tubulaires
Dispositivo para llaves tubulares
Dispositivo para chaves tubulares

OPTIONAL



D741438ZB

Tracer point TE07
Tastatore TE07
Taster TE07
Palpeur TE07
Palpador TE07
Palpador TE07



D741439ZB

Cutter FE07
Fresa FE07
Fräser FE07
Fraise FE07
Fresa FE07
Fresa FE07



ATTENTION: for repairs or replacement of parts for maintenance, the 'CE' mark is guaranteed only if original spare parts provided by the manufacturer are used.

ATTENZIONE: in caso di riparazioni o sostituzione di pezzi per manutenzione, la marcatura "CE" è garantita solo se vengono utilizzate parti di ricambio originali fornite dal costruttore.

ACHTUNG: bei Reparaturen oder Auswechseln von Teilen zur Instandhaltung wird die CE-Markierung nur bei Verwendung von vom Hersteller gelieferten Originalersatzteilen gewährleistet.

ATTENTION: si vous effectuez des réparations ou que vous remplacez des pièces pendant un entretien, le marquage "CE" n'est garanti que si vous utilisez des pièces de rechange originales fournies par le fabricant.

ATENCIÓN: en caso de reparaciones o sustituciones de las piezas por mantenimiento, se garantiza la marca "CE" sólo si se utilizan partes de repuesto originales suministradas por el constructor.

ATENÇÃO: em caso de reparações ou substituição de peças para manutenção, a marcação "CE" é garantida exclusivamente se forem utilizadas peças de origem fornecidas pelo fabricante.

OPGELET: Bij herstellingen of vervanging van onderdelen ten gevolge van onderhoud, blijft de "CE-markering" enkel geldig bij gebruik van originele vervangstukken, geleverd door de fabrikant.



SILCA S.p.A.
Via Podgora, 20 (Z.I.)
31029 VITTORIO VENETO (TV)
Phone +39 0438 9136 Fax +39 0438 913800
www.silca.biz

MINDA SILCA Engineering Ltd.
Plot no. 37 - Toy City
GREATER NOIDA 201308, U.P.
Phone +91 9871397630/31 Fax +91 120 2351301
www.mindasilca.in

Members of the Kaba Group

